

AVI VACUUM CUPS

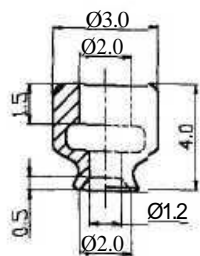

DYT-2

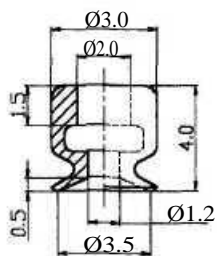

DYT-3.5A

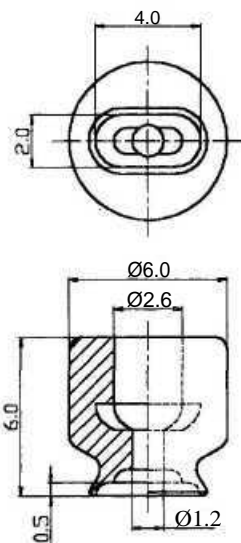

DYT-2X4A

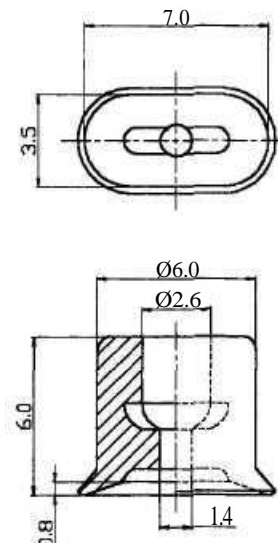

DYT-3.5X7A

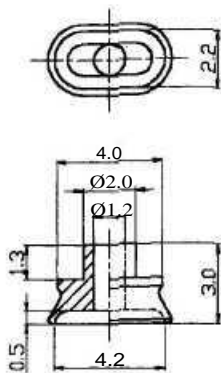

DYT-2X4

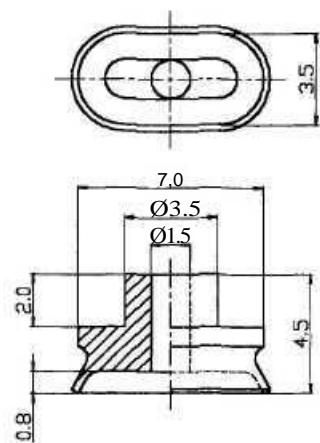

DYT-3.5X7

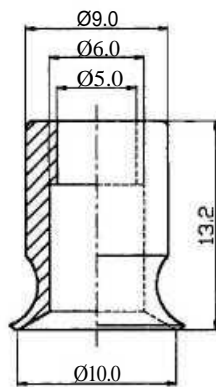

SC01-10

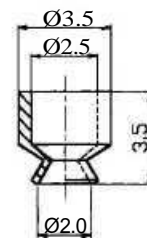

SC02-2

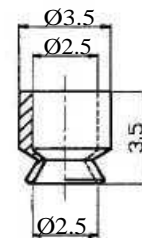

SC02-2.5

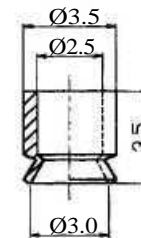

SC02-3

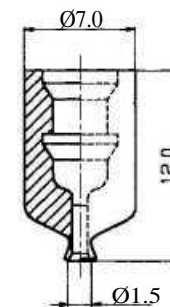

SC03-1.5

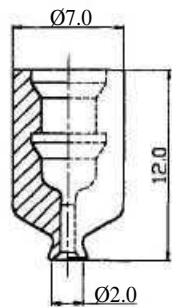

SC03-2

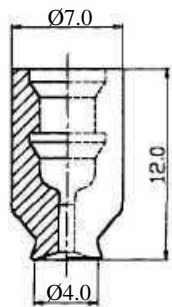

SC03-4

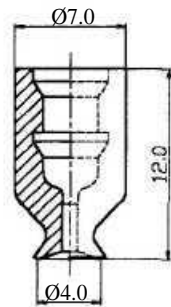

SC03-4LN

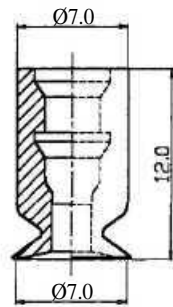

SC03-7

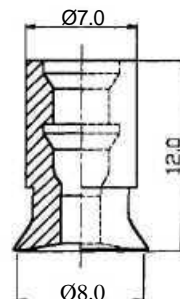

SC03-8

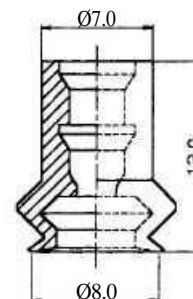

SC03B-8

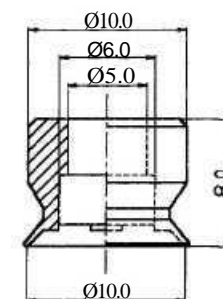

SC04-10

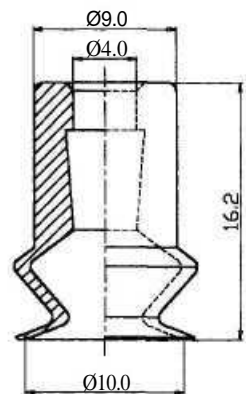

SC05-10

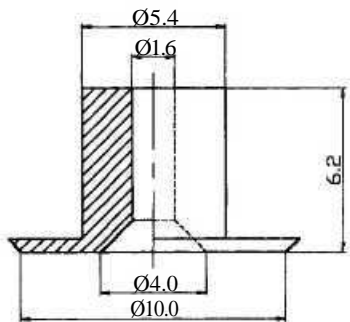

SC06-4

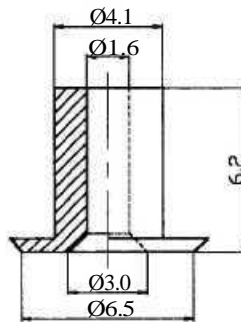

SC06-3

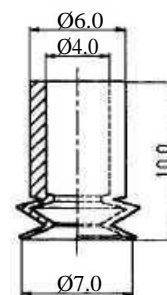

SC07-7

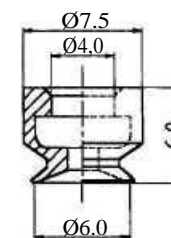

SC08-6

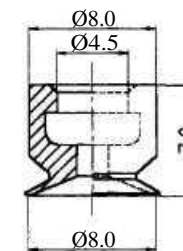

SC08-8

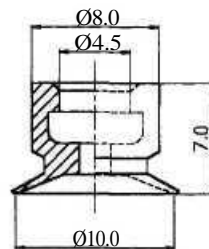

SC08-10

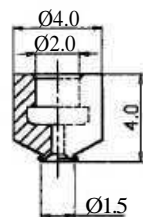

SC09-1.5

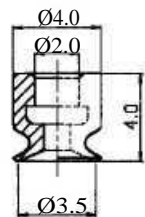

SC09-3.5

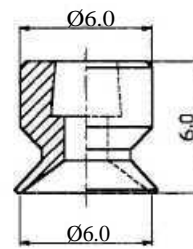

SC10-6

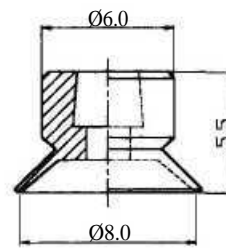

SC10-8

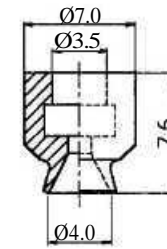

SC11-4

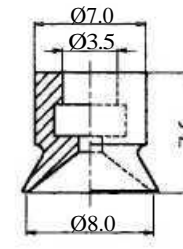

SC11-8

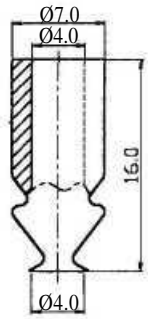

SC05B-4

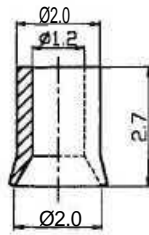

SC13-2

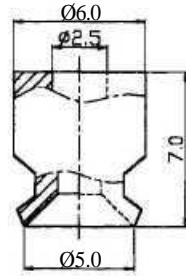

SC20-5

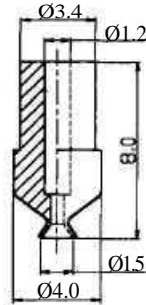

SC21-1.5

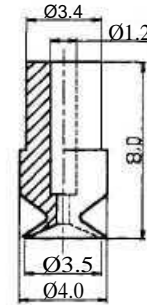

SC21-1.5

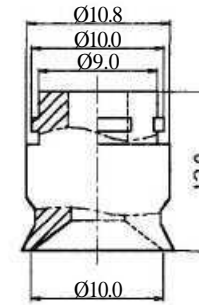

SC25-10

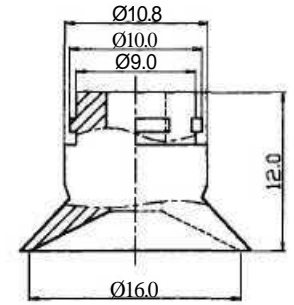

SC25-16

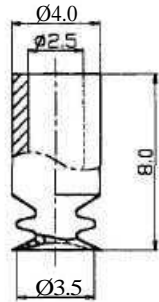

SC32-3.5

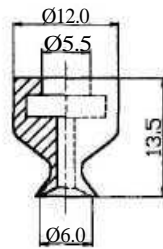

SC33-6

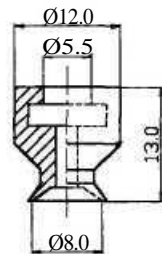

SC33-8

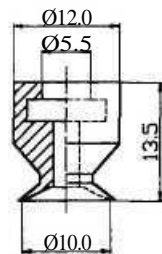

SC33-10

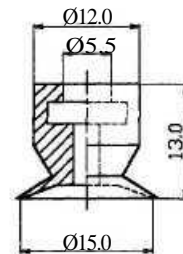

SC33-15

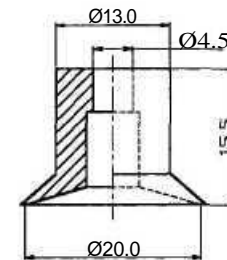

SC34-20

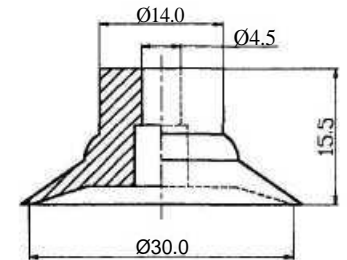

SC34-30

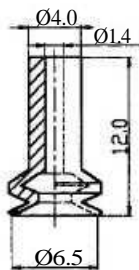

SC35-6.5

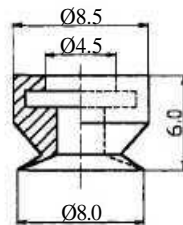

SC36-8

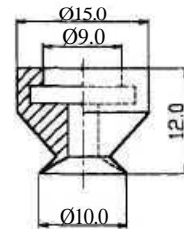

SC37-10

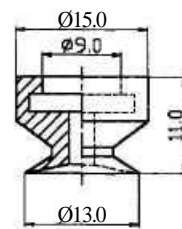

SC37-13

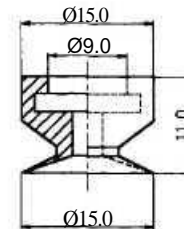

SC37-10

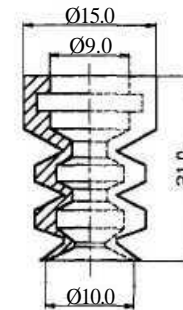

SC37B-10

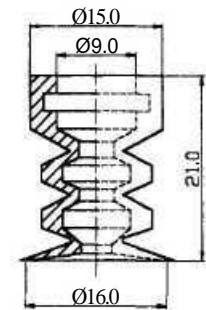

SC37B-16

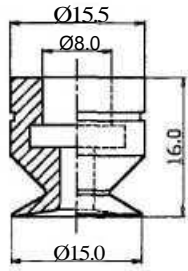

SC38-15

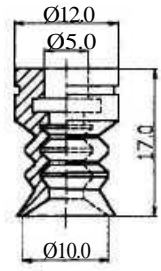

SC39-10

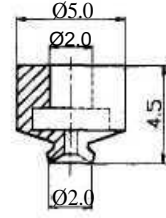

SC43-2

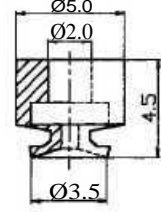

SC43-3.5

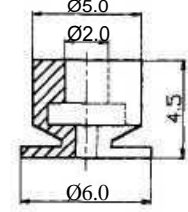

SC43-3.5

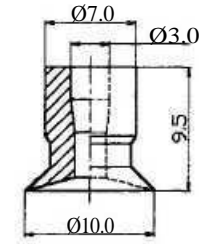

SC44-10

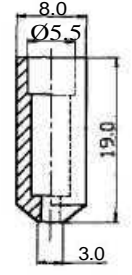

SC45-3

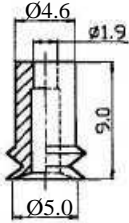

SC05-5

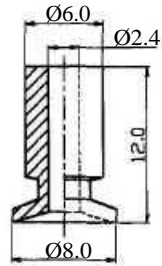

SC50-8

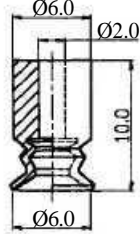

SC53B-6

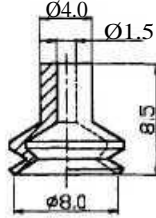

SC54B-8

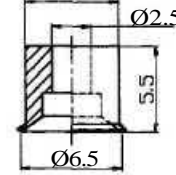

SC55-6.5

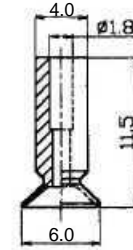

SC61-6

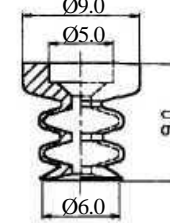

SC57B-6(S)

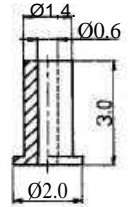

HSC 1-6

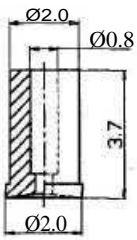

HSC 2-4

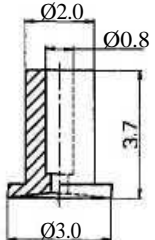

HSC 3-2

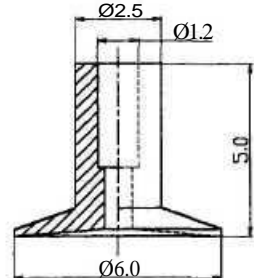

HSC 6-4

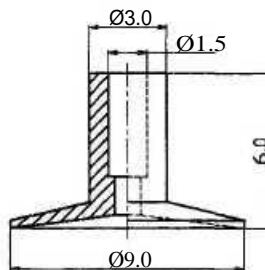

HSC 9-5

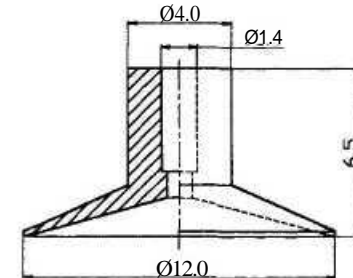

HSC12-5

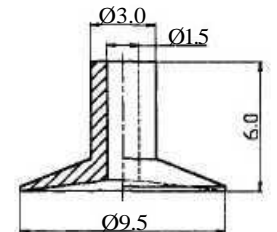

HSC23-9.5

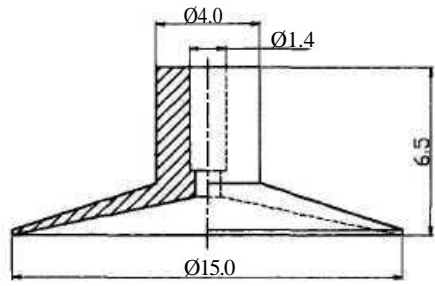

HSC15

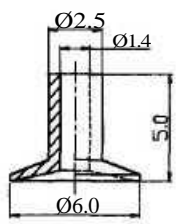

HSC24-6